

PDS_342

METAL TUMBLE BAR



MANUAL : M342
SALESSTATUS : STD
PRODUCT DIMENSIONS : 1250 x 125 x 32 mm

MATERIAL :

EN metal tumble bar

- powder coated or in glossy stainless steel
- with rounded edges
- exterior tube diameter 32 mm (wall thickness 2 mm)
- bolts not included - available separately
- optional - assembly set for tumble bar • 4x screw (DIN571 Ø8) and washer • 4x bolt cover (red, green or black)

NL metalen duikelstang

- gepoedercoat of in roestvrij staal
- met afgeronde hoeken
- buitendiameter buis 32 mm (wanddikte 2 mm)
- bouten niet meegeleverd - apart verkrijgbaar
- optioneel - bevestigingsset voor duikelstang • 4x screw (DIN571 Ø8) and washer • 4x bolt cover (red, green or black)

FR barre à culbutter en métal

- thermolaqué par poudrage ou en acier inoxydable brillant
- avec des bords arrondis
- diamètre extérieur du tube 32 mm (épaisseur paroi 2 mm)
- fourni sans les boulons - disponible séparément
- optionnel - jeu de fixation pour barre à culbutter • 4x vis (DIN571 Ø8) et rondelles • 4x cache-écrou (rouge, vert ou noir)

DE Metallreckstange

- pulverbeschichtet oder in glänzendem rostfreien Stahl
- mit abgerundeten Ecken
- Außendurchmesser Rohr 32 mm (Wandstärke 2 mm)
- Schrauben werden nicht mitgeliefert - separat verfügbar
- optional - Montageset für Reckstange • 4x Schrauben (DIN571 Ø8) und Scheibe • 4x Bolzenabdeckung (Rot, Grün oder schwarz)







ES barra para voltear metálica

- termolacada por espolvoreado o acero inoxidable pulido
- con cantos redondeados
- diámetro exterior del tubo 32 mm (espesor del material 2 mm)
- viene sin pernos - disponible por separado
- opcional - Montageset für Reckstange asamblea fijada para barra • 4x tornillo (DIN571 Ø8) y arandela • 4x perno de plástico (rojo, verde o negro)

PL metalowy drążek do akrobacji

- malowany proszkowo lub ze stali nierdzewnej z połyskiem
- zaokrąglone brzegi
- średnica zewnętrzna drążka 32 mm (grubość ścianki 2 mm)
- zestaw montażowy dostępny osobno
- opcjonalny - opcjonalnie do zakupu: zestaw montażowy do drążka • 4x wkręt (DIN571 Ø8) z podkładką • 4x maskownica (czerwona, zielona lub czarna)

PACKAGING

342.	 pcs 2,4 kg	 pcs 5	 126 x 20 x 13 cm	 10 kg
342.	 = 50 pcs 50	 135 x 135 x 65 cm	 515 kg	

METAL TUMBLE BAR

DRAWINGS:

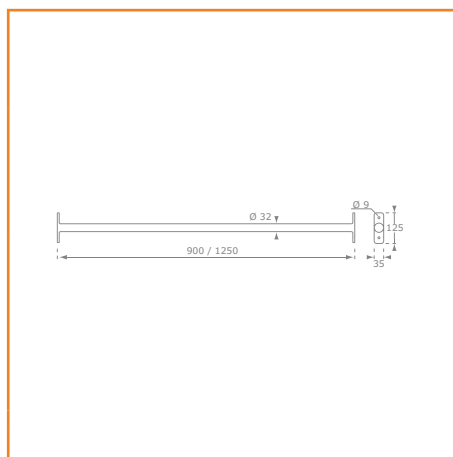

VARIATIONS :

	342.001.009.001	metal tumble bar - 1250 mm - stainless steel
	342.003.009.001	metal tumble bar - 900 mm - stainless steel
	342.011.001.001	metal tumble bar - 1250 mm - red
	342.011.002.001	metal tumble bar - 1250 mm - green
	342.013.001.001	metal tumble bar - 900 mm - red
	342.013.002.001	metal tumble bar - 900 mm - green
	342.080.001.001	assembly set for tumble bar - screws, washers and bolt covers - red
	342.080.002.001	assembly set for tumble bar - screws, washers and bolt covers - green
	342.080.006.001	assembly set for tumble bar - screws, washers and bolt covers - black