

PDS_852.002

PLASTIC BOLT COVER 8 / 10 MM (MEDIUM)

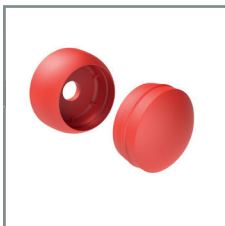

MANUAL : -
SALESSTATUS : STD
PRODUCT DIMENSIONS : 34 x 22 x 22 mm

MATERIAL :

EN plastic bolt cover

- injection moulded
- unremovable
- for hexagonal head and other bolts and nuts
- consisting of two parts

NL kunststof afdekdop voor bouten

- spuitgegoten
- niet verwijderbaar
- voor zeskkanten en andere bouten en moeren
- tweedelig

FR cache-écrou en plastique

- moulé par injection
- inviolable
- pour boulons et écrous hexagonaux et autres
- composé de deux pièces

DE kunststoff Bolzenabdeckung

- Spritzguss
- nicht abnehmbar
- für Sechskantschrauben und andere Schrauben und Muttern
- bestehend aus zwei Teilen







ES tapa perno de plástico

- inyectado
- indesmontable
- para tornillos y tuercas hexagonal y otros
- en dos partes

PL plastikowa maskownica

- formowany metodą wtryskową
- montowana na stałe
- do każdego rodzaju śrub
- złożona z dwóch części

PACKAGING





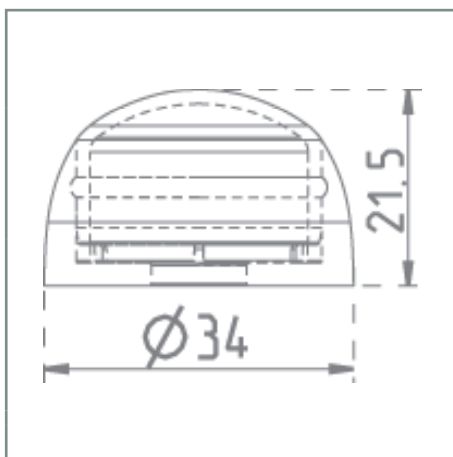

852.002	 1 pcs	 2 pcs	 49 x 29 x 34 cm	 10 kg
852.002	 30	 125 x 82 x 193 cm	 350 kg	

PLASTIC BOLT COVER - 8 /10 MM (MEDIUM)

DRAWINGS:



VARIATIONS :

	852.002.001.001	plastic bolt cover - 8/10 mm - red
	852.002.002.001	plastic bolt cover - 8/10 mm - green
	852.002.003.001	plastic bolt cover - 8/10 mm - yellow
	852.002.004.001	plastic bolt cover - 8/10 mm - blue
	852.002.005.001	plastic bolt cover - 8/10 mm - lime green
	852.002.006.001	plastic bolt cover - 8/10 mm - black